

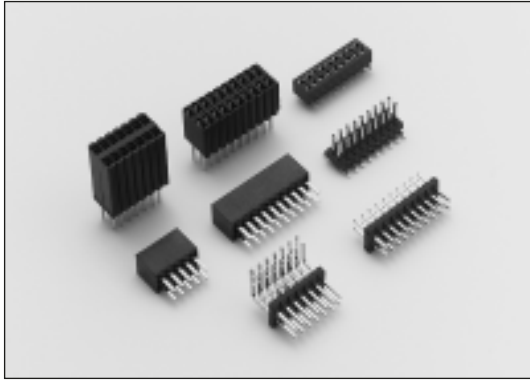

1.27mm PCB Sockets and Headers

Through Board and Surface Mount



A full range of single and double row PCB sockets and headers . Sockets are available in several heights for top or bottom entry application. Headers are available with several body thicknesses. Row spacing 2.54 and 1.27mm.

Material : Polyester UL 94V-0/L.C.P.
Contacts : Phosphor Bronze
Plating : Gold Flash over Nickel
Electrical : See Chapter 15

■ Socket, top entry, through board, 8.50mm

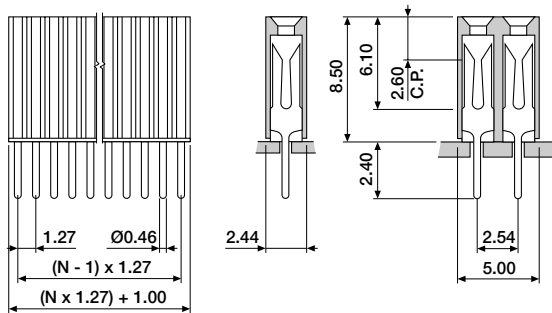

PCB Hole Size = Ø0.60mm

ORDERING INFORMATION

SES-XXDS-0029 single row
SED-XXDS-0029 double row
available circuit sizes:
04 to 40 for single row
06 to 80 for double row

■ Socket, top entry, through board, 4.60mm

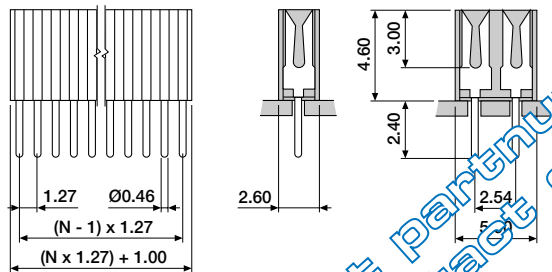

PCB Hole Size = Ø0.60mm

ORDERING INFORMATION

SES-XXDS-2029 single row
SED-XXDS-2029 double row
available circuit sizes:
04 to 40 for single row
06 to 80 for double row

■ Socket, top entry, surface mount, 5.80mm

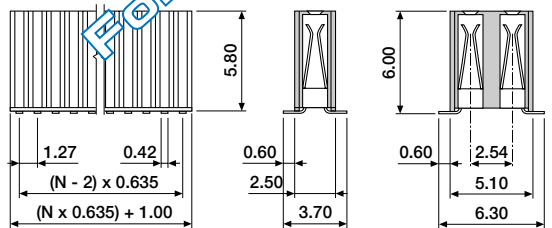

PCB Pad Size = 0.63 x 2.03mm

ORDERING INFORMATION

SES-XXSM-0629 single row (first contact up)
SES-XXSM-0929 single row (first contact down)
SED-XXSM-0029 double row
available circuit sizes:
04 to 40 single row
06 to 80 double row



1.27mm PCB Sockets and Headers

Through Board and Surface Mount

■ Socket, top entry, through board, 4.30/3.60mm

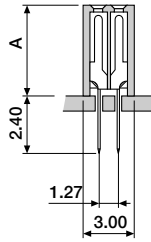
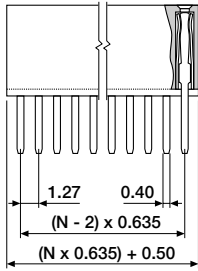

ORDERING INFORMATION

SED-XXDS-4029 double row, A = 4.30mm
 SED-XXDS-4129 double row, A = 3.40mm

available circuit sizes:
 06 to 80 for double row

PCB Hole Size = Ø0.60mm

■ Socket, top entry, surface mount, 4.50/3.60mm

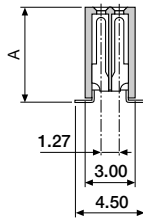
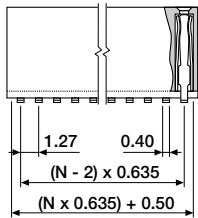

ORDERING INFORMATION

SED-XXSM-4029 double row, A = 4.50mm
 SED-XXSM-4129 double row, A = 3.60mm

available circuit sizes:
 06 to 80 for double row

PCB Pad Size = 0.76 x 2.05mm

■ Socket, top entry, surface mount, low profile, 2.20mm

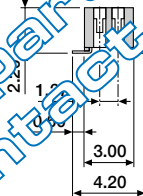
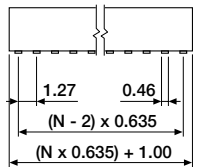

ORDERING INFORMATION

SED-XXSM-4029 double row

available circuit sizes:
 10 to 80

PCB Pad Size = 0.76 x 1.47mm

■ Socket, bottom entry, surface mount, low profile, 2.20mm

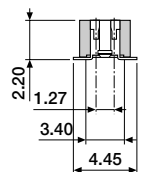
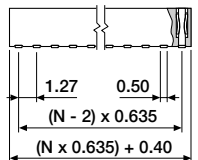

ORDERING INFORMATION

SED-XXSM-7029 double row

available circuit sizes:
 10 to 80

PCB Pad Size = 0.71 x 1.26mm



1.27mm PCB Sockets and Headers

Through Board and Surface Mount

■ Header, straight, through board

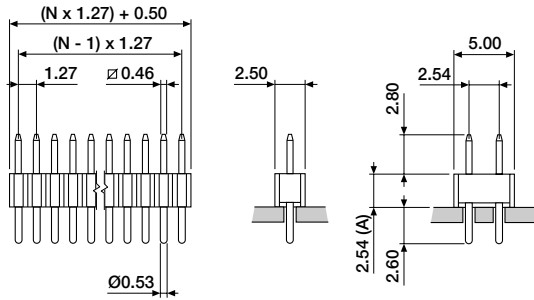

PCB Hole Size = Ø0.65mm

ORDERING INFORMATION

HES-XXDS-0079	single row
HED-XXDS-0079	double row
available circuit sizes:	
04 to 40 for single row	
06 to 80 for double row	

Contact sales office for extended headers and body dimensions. (A = 1.70 or 3.00mm)

■ Header, straight, through board

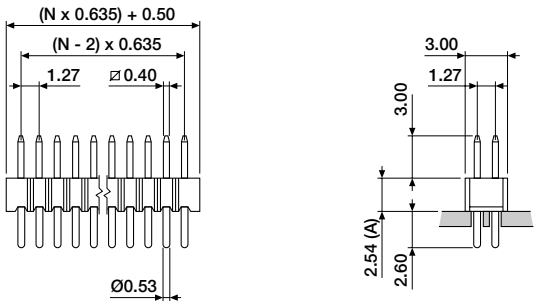

PCB Hole Size = Ø0.70mm

ORDERING INFORMATION

HED-XXDS-0079	double row
available circuit sizes:	
06 to 80	

Contact sales office for extended headers and body dimensions. (A = 1.70 or 3.00mm)

■ Header, straight, surface mount

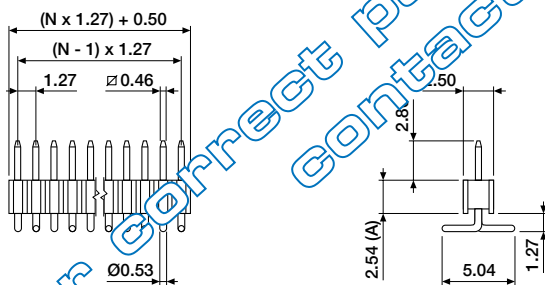

PCB Pad Size = 0.76 x 3.03mm (single row)

ORDERING INFORMATION

HES-XXSM-0079	single row (first contact up)
HES-XXSM-0179	single row (first contact down)
HED-XXSM-0079	double row
available circuit sizes:	
04 to 40 single row	
06 to 80 double row	

Contact sales office for extended headers and body dimensions. (A = 1.70 or 3.00mm)

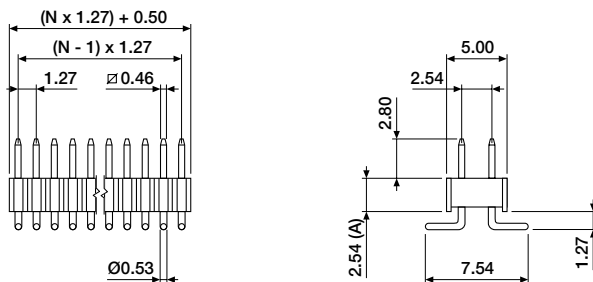

PCB Pad Size = 0.76 x 3.98mm (double row)



1.27mm PCB Sockets and Headers

Through Board and Surface Mount

■ Header, right angle, through board

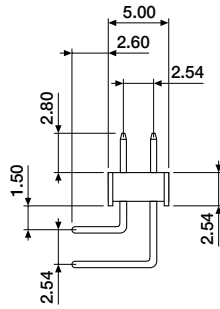
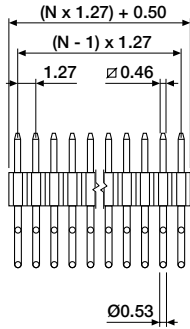

PCB Hole Size = Ø0.65mm

ORDERING INFORMATION

HED-XXDS-1079 double row
 available circuit sizes:
 06 to 80

■ Header, straight, surface mount

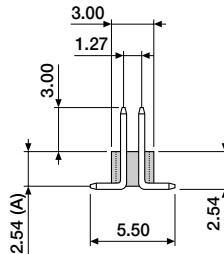
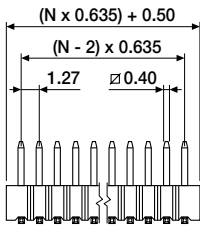

PCB Pad Size = 0.76 x 2.40mm

ORDERING INFORMATION

HED-XXSI-1079 double row
 available circuit sizes:
 06 to 80

Contact sales office for body dimensions. (A = 1.70 or 3.00mm)

■ Header, straight, through board, low profile

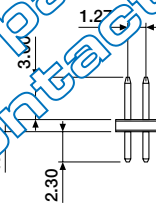
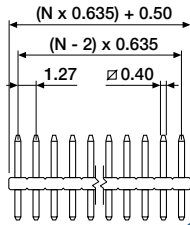

PCB Hole Size = Ø0.65mm

ORDERING INFORMATION

HED-XXDS-4079 double row
 available circuit sizes:
 10 to 80

■ Header, straight, surface mount, low profile

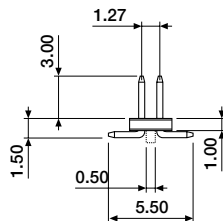
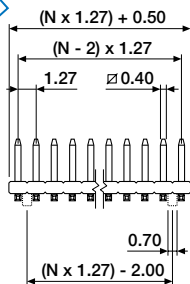

PCB Pad Size = 0.76mm x 2.40mm
PCB Hole Size = Ø0.90mm

ORDERING INFORMATION

HED-XXSM-4079 double row
 available circuit sizes:
 10 to 80