

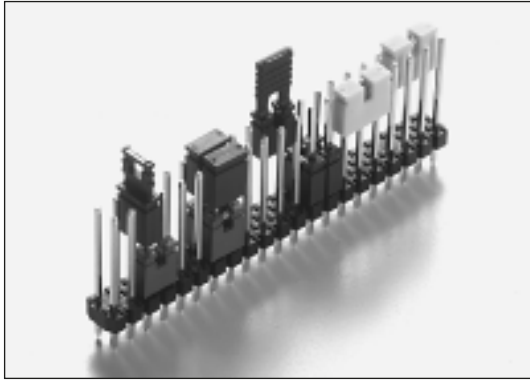

# Shunts

## 2.00mm, 2.54mm and 5.08mm



Programming shunts. All models have a double sided contact design. Open and closed models have fingernail grip design for easy removal by hand. The open models 5100/5126 are supplied on strips of 20 pcs for easy installation

- Material : Glass-filled PBT, UL 94V-0
- Contacts : Phosphor Bronze
- Plating : Tin or Selective Gold over Nickel
- Electrical : See Chapter 15

### ■ 2.00mm, open top, with test feature

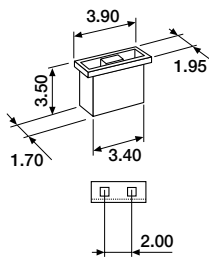

#### ORDERING INFORMATION

- PSH-2000-0000 tin plated, colour: black
- PSH-2000-0026 gold plated, colour: blue

Other colours are available on request.

OBSOLETE

### ■ 2.54mm, closed top

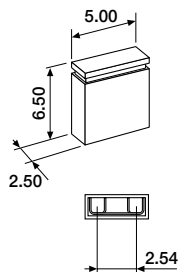

#### ORDERING INFORMATION

- PSH-2540-1000 tin plated, colour: black
- PSH-2540-1026 gold plated, colour: blue

Other colours are available on request.

### ■ 2.54mm, open top, with test feature

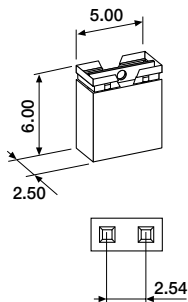

#### ORDERING INFORMATION

- PSH-2540-5100 tin plated, colour: black
- PSH-2540-5126 gold plated, colour: blue

Shunts are supplied in easily break away strips off 20 pieces. Other colours are available on request.



# Shunts

2.00mm, 2.54mm and 5.08mm

## ■ 2.54mm, extended grip

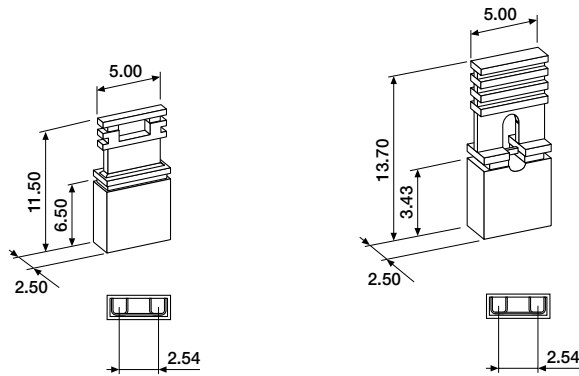

### ORDERING INFORMATION

PSH-2540-2000	11.50mm, tin plated, colour: black
PSH-2540-2026	11.50mm, gold plated, colour: blue
PSH-2540-3000	13.70 mm, tin plated, colour: black

## ■ 5.08mm, closed top, with test feature

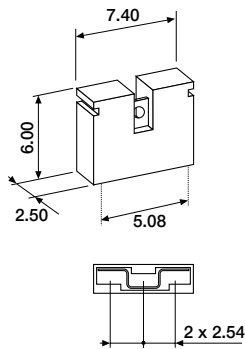

### ORDERING INFORMATION

PSH-5080-1008	tin plated, colour: white
PSH-5080-1028	gold plated, colour: white

Due to the special contact design this shunt can be used for short circuiting three square pins of 0.64mm.

## ■ 5.08mm, closed top

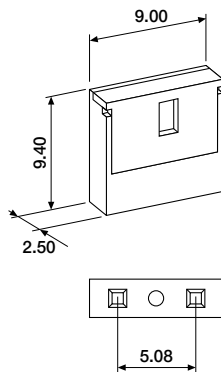

### ORDERING INFORMATION

PSH-5080-1020	gold plated, colour: black
---------------	----------------------------

**OBSOLETE**