

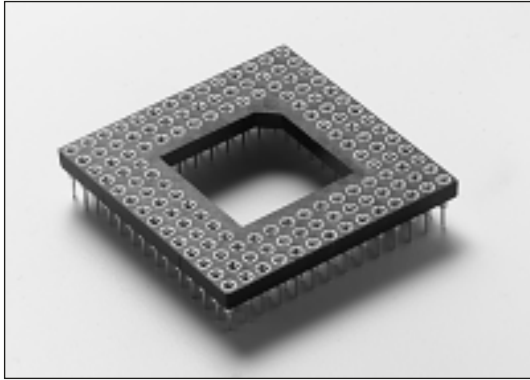

PGA Sockets

Machine Tooled Contacts



A range of over 200 configurations can be delivered in arrays of 5 x 5 to 21 x 21 positions. The contact clip is a special 6 finger low insertion force model.

- Material : Glass-filled Thermoplastic Polyester, UL 94V-0
- Contacts : Copper Alloy (outer shell)
Beryllium Copper (spring contact)
- Plating : Tin or Gold over Nickel

General

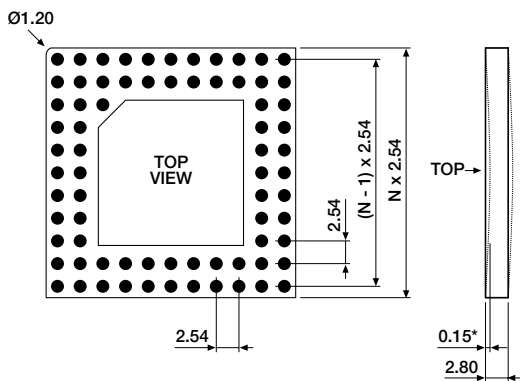

ORDERING INFORMATION

- PGA-XXDS-XX70-00 tin shell, gold plated clip, closed window
- PGA-XXDS-XX70-10 tin shell, gold plated clip, open window
- number of rows: 07 to 21
- available circuit sizes: any configuration

*Max after assembly of pins.
Contact sales office for models with wire wrap pins
Products are subject to M.O.Q.

Popular configurations 10 x 10 array

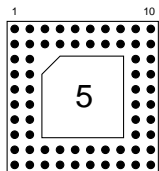

PGA-64DS-1070-00
PGA-64DS-1070-10

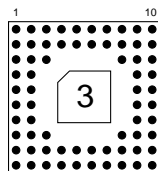

PGA-68DS-1070-00
PGA-68DS-1070-10

Popular configurations 11 x 11 array

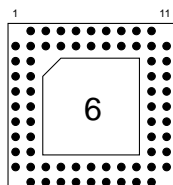

PGA-68DS-1170-00
PGA-68DS-1170-10

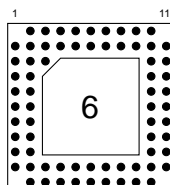

PGA-69DS-1170-00
PGA-69DS-1170-10

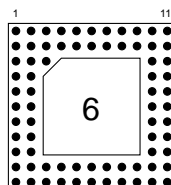

PGA-73DS-1170-00
PGA-73DS-1170-10

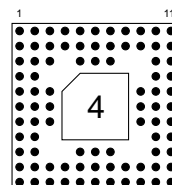

PGA-85DS-1170-00
PGA-85DS-1170-10

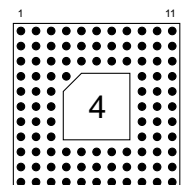

PGA-97DS-1170-00
PGA-97DS-1170-10

Circuit sizes given in hexadecimal form: A = 10, B = 11, C = 12, D = 13, E 14, F = 15, etc. Example E5 = 145 circuits



PGA Sockets

Machine Tooled Contacts

■ Popular configurations 12 x 12 array

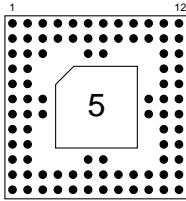

PGA-89DS-1270-00
PGA-89DS-1270-10

■ Popular configurations 13 x 13 array

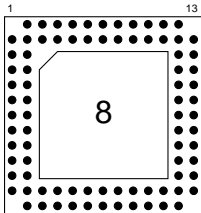

PGA-84DS-1370-00
PGA-84DS-1370-10

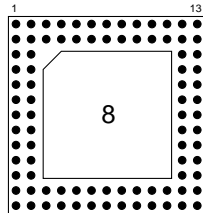

PGA-88DS-1370-00
PGA-88DS-1370-10

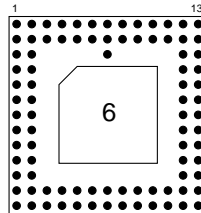

PGA-89DS-1370-00
PGA-89DS-1370-10

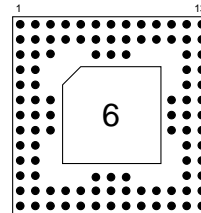

PGA-A1DS-1370-00
PGA-A1DS-1370-10

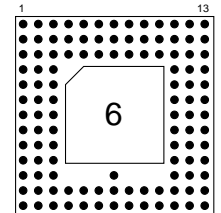

PGA-B4DS-1370-00
PGA-B4DS-1370-10

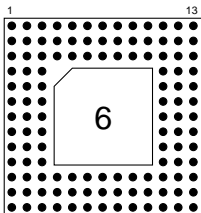

PGA-C0DS-1370-00
PGA-C0DS-1370-10

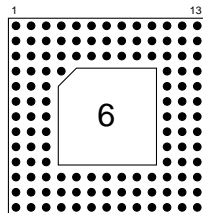

PGA-C1DS-1370-00
PGA-C1DS-1370-10

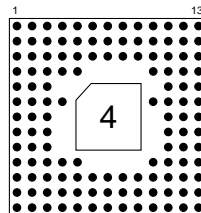

PGA-C8DS-1370-00
PGA-C8DS-1370-10

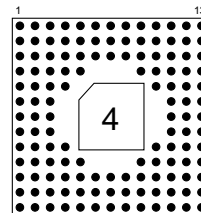

PGA-D2DS-1370-00
PGA-D2DS-1370-10

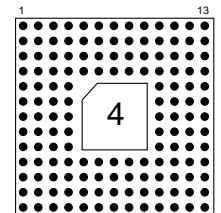

PGA-E4DS-1370-00
PGA-E4DS-1370-10

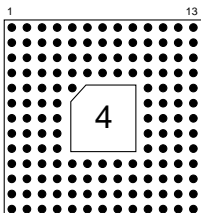

PGA-E5DS-1370-00
PGA-E5DS-1370-10

Circuit sizes given in hexadecimal form: A = 10, B = 11, C = 12, D = 13, E 14, F = 15, etc. Example E5 = 145 circuits



■ Popular configurations 14 x 14 array

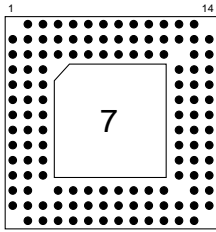

PGA-C5DS-1470-00
PGA-C5DS-1470-10

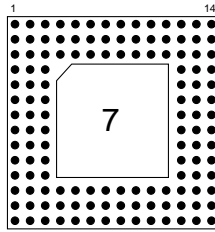

PGA-D2DS-1470-00
PGA-D2DS-1470-10

■ Popular configurations 15 x 15 array

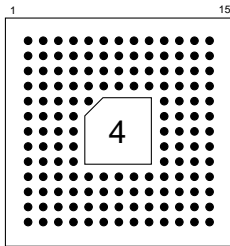

PGA-E5DS-1570-00
PGA-E5DS-1570-10

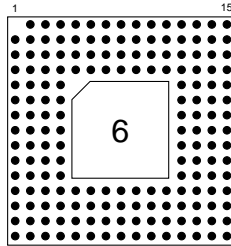

PGA-H5DS-1570-00
PGA-H5DS-1570-10

■ Popular configurations 17 x 17 array

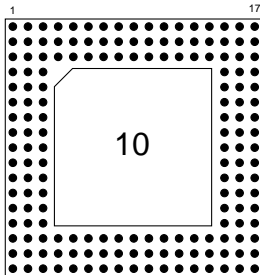

PGA-G8DS-1770-00
PGA-G8DS-1770-10

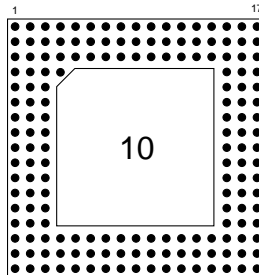

PGA-G9DS-1770-00
PGA-G9DS-1770-10