



# Mini-DIN Connectors



A full range of mini-DIN connectors as used for industrial and various computer interface applications. All cable connectors can be supplied as assembled interface cable. As of 500 pcs, the cable connectors can also be supplied in moulded-on quality.

All dimensions are for reference only, due to the rapid changing of available models.

## ■ Mini-DIN, male

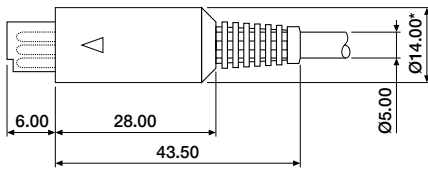

\*Ø12.00mm if moulded

### ORDERING INFORMATION

MDM-XXHS-0000

available circuit sizes:  
03, 04, 05, 06, 07, 08, 09

## ■ Mini-DIN, female

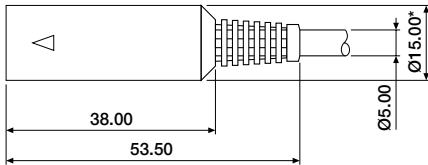

\*Ø12.00mm if moulded

### ORDERING INFORMATION

MDF-XXHS-0000

available circuit sizes:  
03, 04, 05, 06, 07, 08, 09

## ■ Mini-DIN, female, PCB-mount, right-angle

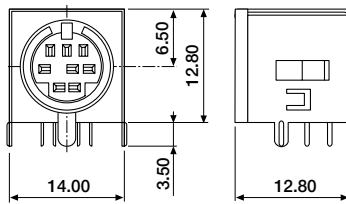

Fully shielded

### ORDERING INFORMATION

MDF-XXDS-1150

fully shielded

available circuit sizes:  
03, 04, 05, 06, 07, 08, 09



# Mini-DIN Connectors

## ■ Mini-DIN, female, PCB/panel mount

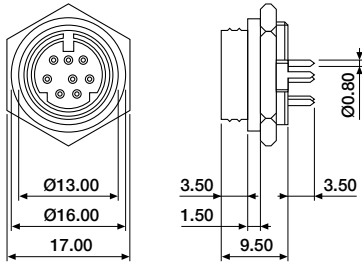

### ORDERING INFORMATION

**MDF-XXDP-2000** PCB mount with locking nut  
available circuit sizes:  
03, 04, 05, 06, 07, 08

## ■ Mini-DIN, female, panel mount with flange

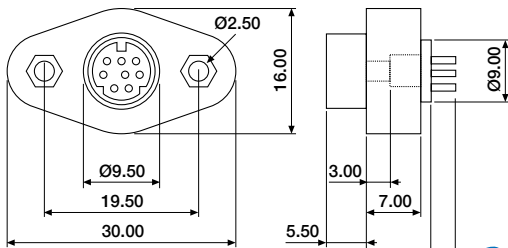

### ORDERING INFORMATION

**MDF-XXDP-0000** with solder tails  
available circuit sizes:  
03, 04, 05, 06, 07, 08

## ■ Mini-DIN, female, panel mount with flange

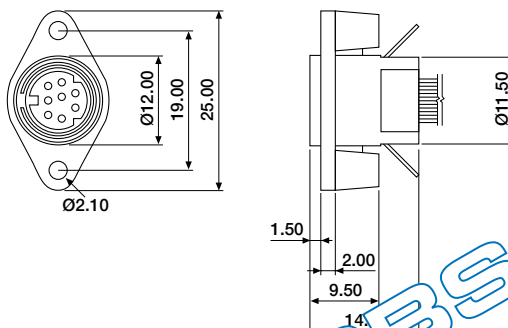

### ORDERING INFORMATION

**MDF-XXDP-2000** with wires (200mm)  
available circuit sizes:  
03, 04, 05, 06, 07, 08



## ■ Mini-DIN contact configuration

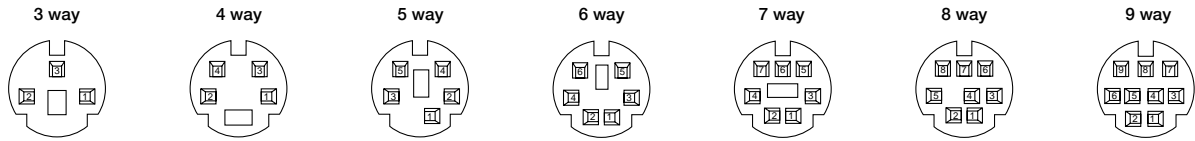

## ■ Mini-DIN PCB layout and pin numbering, straight model

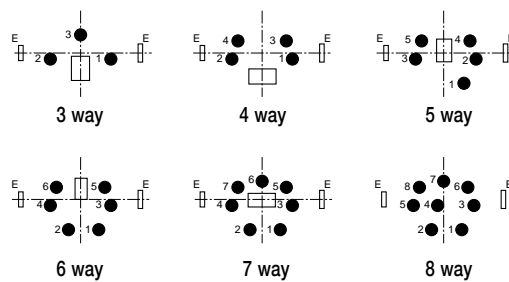
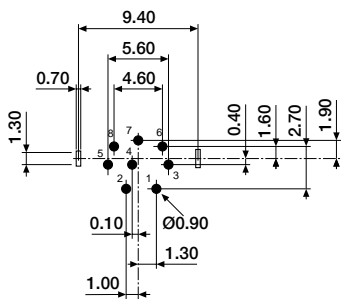

## ■ Mini-DIN PCB layout and pin numbering, right-angle model

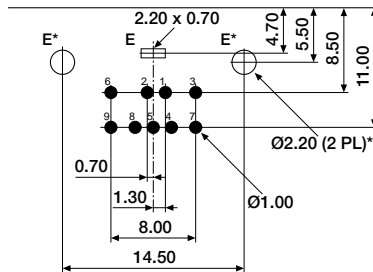
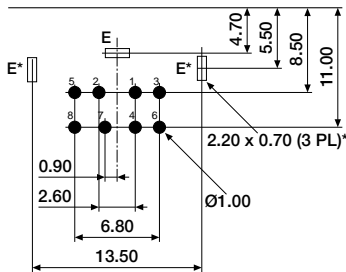

\*Not needed if unshielded model is used  
3 to 8 way

\*Not needed if unshielded model is used  
9 way

