



PCB Terminals and Turret Lugs

Machine Tooled



Another range of special machine tooled terminals and turret legs for PCB applications. All terminals are subject to minimum order quantities.

Material : Brass

Plating : Tin over Copper
Gold over Nickel

Tolerances : If tolerances are important, ask for individual sales drawings.

■ PCB terminals, KPT series

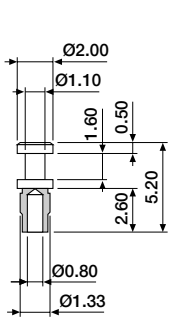

KPT-0008-0000 tin plated
KPT-0008-0020 gold plated

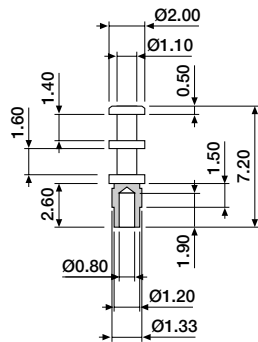

KPT-0010-0000 tin plated
KPT-0010-0020 gold plated

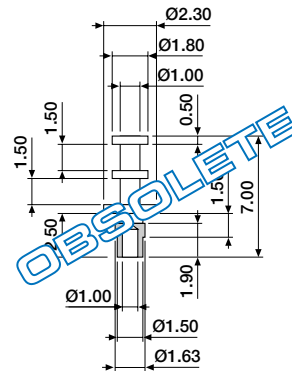

KPT-0012-0000 tin plated
KPT-0012-0020 gold plated

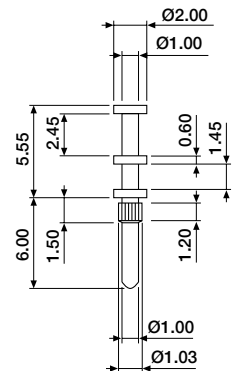

KPT-0013-0000 tin plated
KPT-0013-0020 gold plated

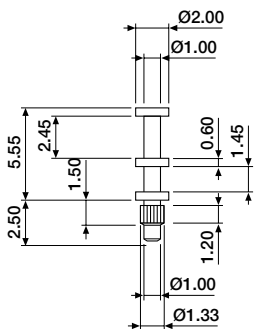

KPT-0014-0000 tin plated
KPT-0014-0020 gold plated

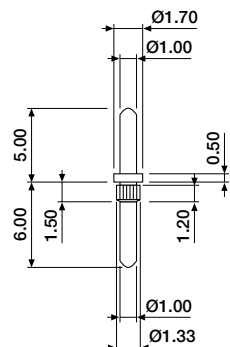

KPT-0015-0000 tin plated
KPT-0015-0020 gold plated

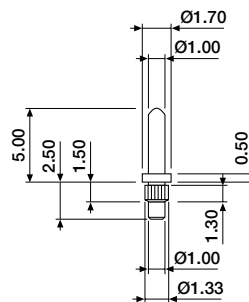

KPT-0016-0000 tin plated
KPT-0016-0020 gold plated

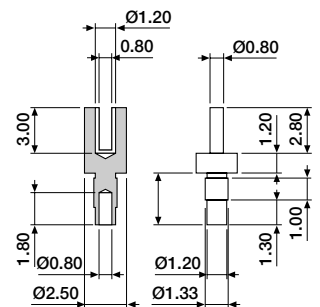

KPT-0017-0000 tin plated
KPT-0017-0020 gold plated



PCB Terminals and Turret Lugs

Machine Tooled

■ PCB terminals, KPT series (contd.)

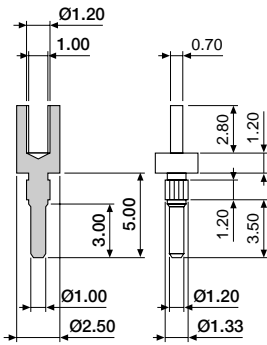

KPT-0018-0000 tin plated
KPT-0018-0020 gold plated

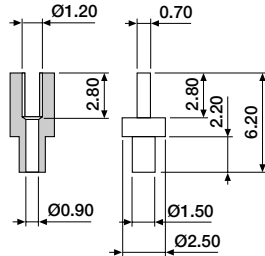

KPT-0019-0000 tin plated
KPT-0019-0020 gold plated

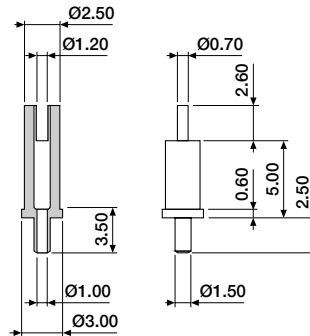

KPT-0020-0000 tin plated
KPT-0020-0020 gold plated

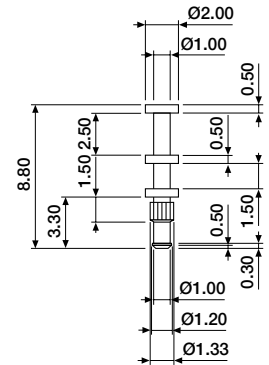

KPT-0025-0000 tin plated
KPT-0025-0020 gold plated

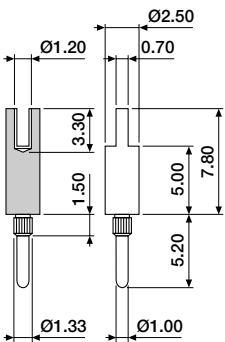

KPT-0030-0000 tin plated
KPT-0030-0020 gold plated

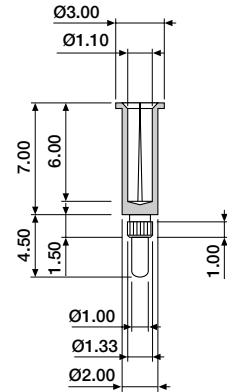

KPT-0032-0020 gold plated

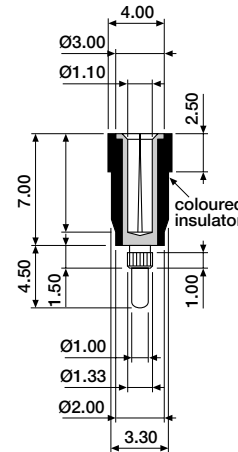

KPT-0034-0020 gold plated (black)
KPT-0034-0022 gold plated (red)

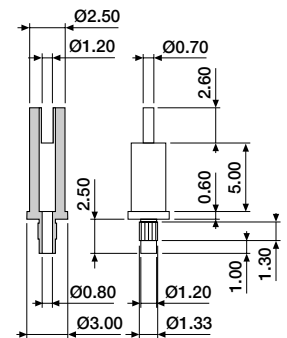

KPT-0051-0000 tin plated
KPT-0051-0020 gold plated

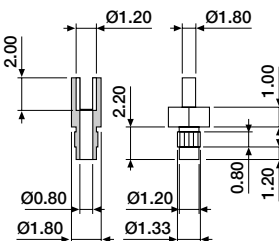

KPT-0053-0000 tin plated
KPT-0053-0020 gold plated

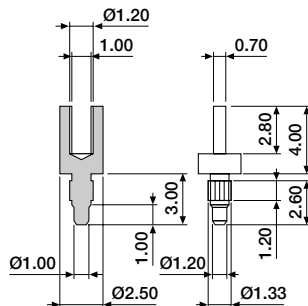

KPT-0058-0000 tin plated
KPT-0058-0020 gold plated

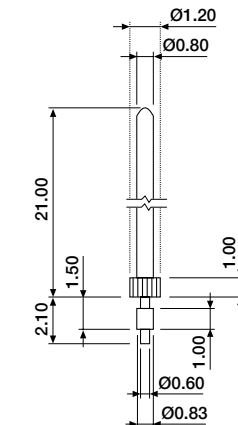

KPT-0071-0000 tin plated
KPT-0071-0020 gold plated

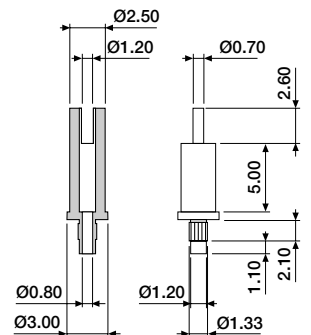

KPT-0077-0000 tin plated
KPT-0077-0020 gold plated



PCB Terminals and Turret Lugs

Machine Tooled

■ PCB terminals, KPT series (contd.)

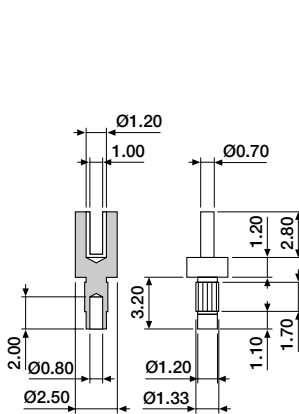

KPT-0078-0000 tin plated
KPT-0078-0020 gold plated

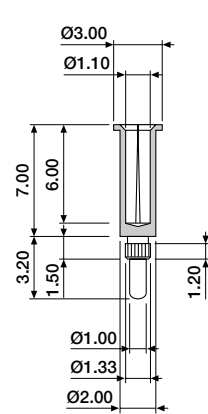

KPT-0079-0020 gold plated

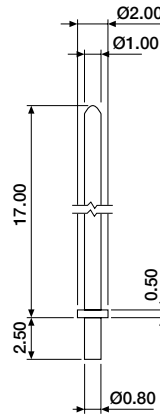

KPT-0088-0000 tin plated
KPT-0088-0020 gold plated

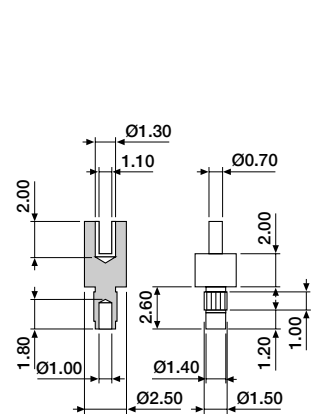

KPT-0094-0000 tin plated
KPT-0094-0020 gold plated

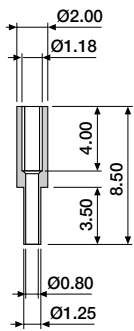

KPT-0152-0000 tin plated

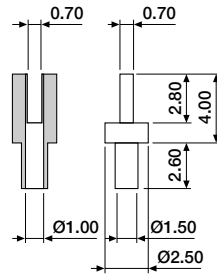

KPT-0161-0000 tin plated
KPT-0161-0020 gold plated

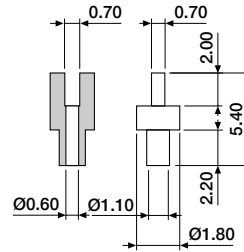

KPT-0164-0000 tin plated
KPT-0164-0020 gold plated

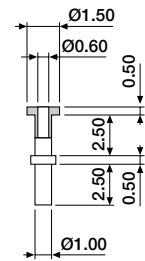

KPT-0165-0000 tin plated
KPT-0165-0020 gold plated

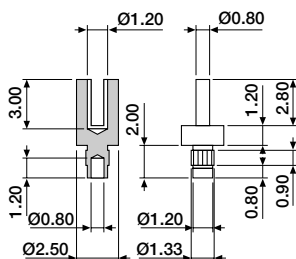

KPT-0169-0000 tin plated
KPT-0169-0020 gold plated

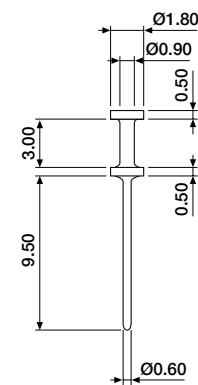

KPT-0190-0000 tin plated
KPT-0190-0020 gold plated

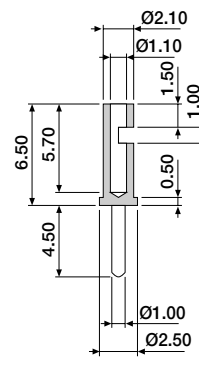

KPT-0207-0020 gold plated

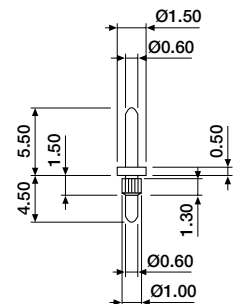

KPT-0212-0000 tin plated
KPT-0212-0020 gold plated



PCB Terminals and Turret Lugs

Machine Tooled

■ PCB terminals, KPT series (contd.)

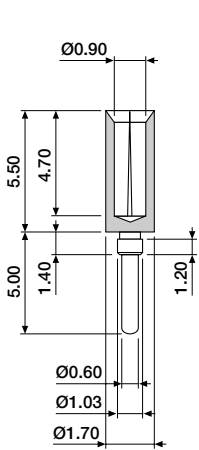

KPT-0216-0020 gold plated

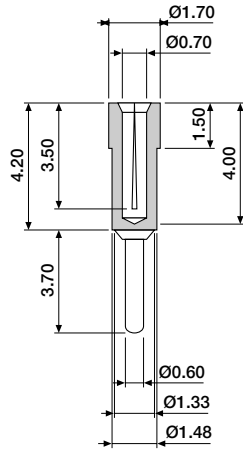

KPT-0218-0020 gold plated

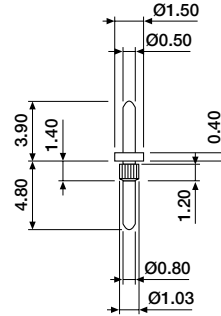

KPT-0219-0020 gold plated

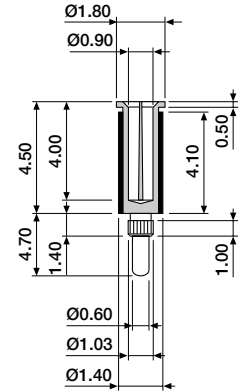

KPT-0222-0020 gold plated

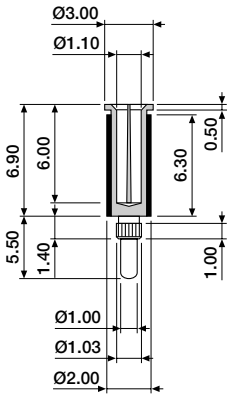

KPT-0223-0020 gold plated

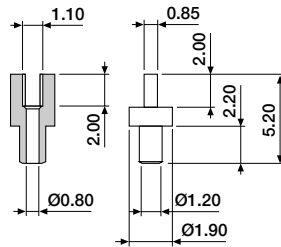

KPT-0242-0000 tin plated
KPT-0242-0020 gold plated

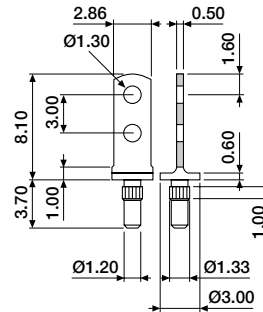

KPT-0254-0000 tin plated
KPT-0254-0020 gold plated

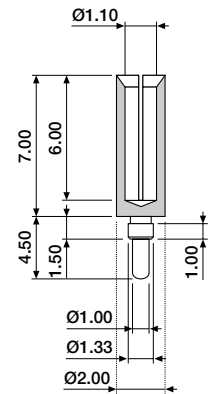

KPT-0266-0020 gold plated

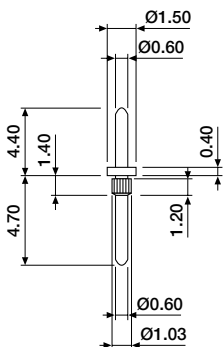

KPT-0299-0000 tin plated
KPT-0299-0020 gold plated

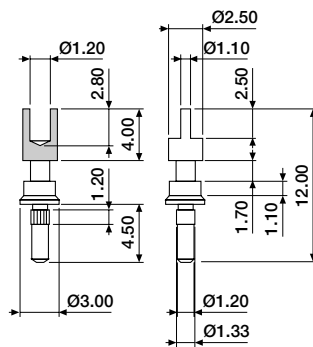

KPT-0322-0000 tin plated
KPT-0322-0020 gold plated

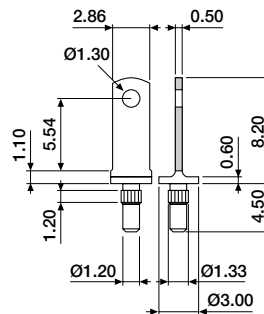

KPT-0323-0000 tin plated
KPT-0323-0020 gold plated

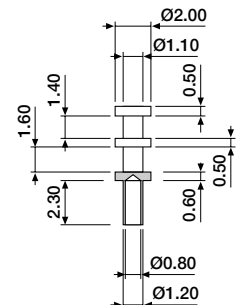

KPT-0325-0000 tin plated
KPT-0325-0020 gold plated



■ PCB terminals, KPT series (contd.)

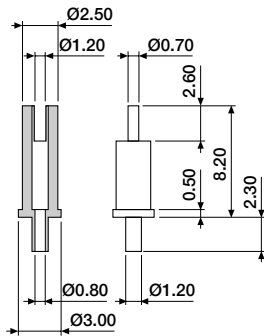

KPT-0326-0000 tin plated
KPT-0326-0020 gold plated

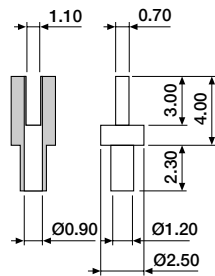

KPT-0335-0000 tin plated
KPT-0335-0020 gold plated

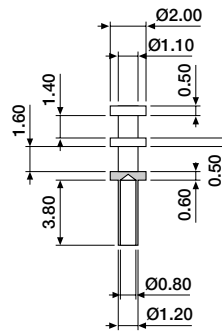

KPT-0344-0000 tin plated
KPT-0344-0020 gold plated

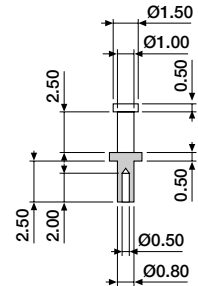

KPT-0346-0000 tin plated
KPT-0346-0020 gold plated

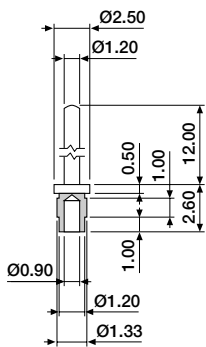

KPT-0356-0000 tin plated
KPT-0356-0020 gold plated

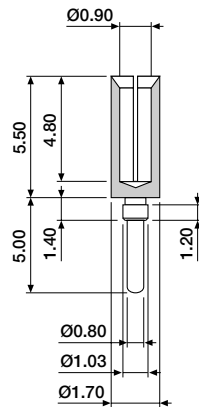

KPT-0599-0020 gold plated

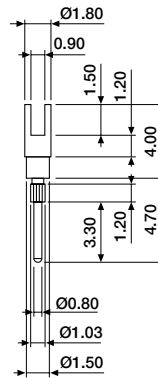

KPT-0600-0000 tin plated
KPT-0600-0020 gold plated

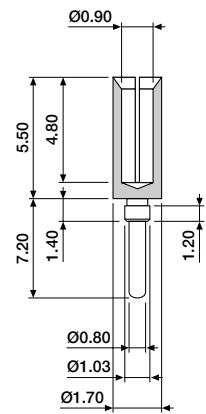

KPT-0668-0000 tin plated

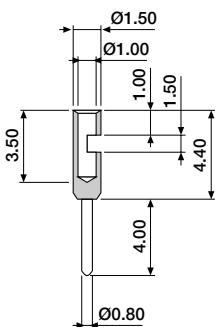

KPT-0760-0020 gold plated

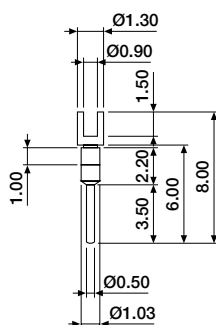

KPT-0788-0000 tin plated
KPT-0788-0020 gold plated

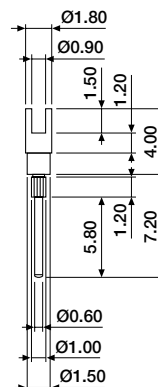

KPT-0809-0000 tin plated
KPT-0809-0020 gold plated

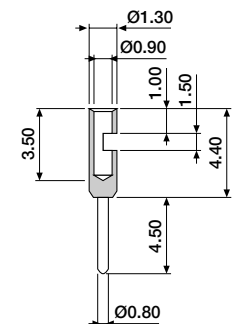

KPT-0838-0020 gold plated



PCB Terminals and Turret Lugs

Machine Tooled

■ PCB terminals, KPT series (contd.)

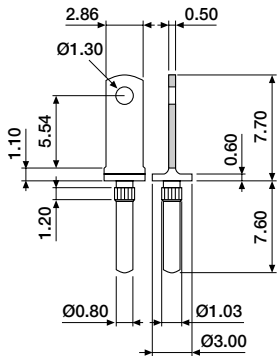

KPT-0902-0000 tin plated
KPT-0902-0020 gold plated

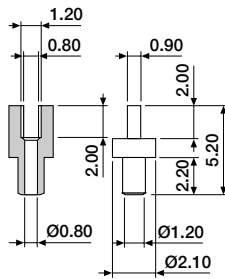

KPT-0938-0000 tin plated
KPT-0938-0020 gold plated

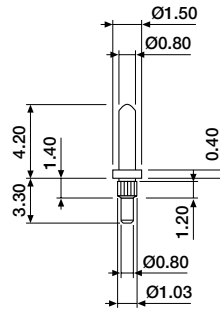

KPT-1017-0020 gold plated

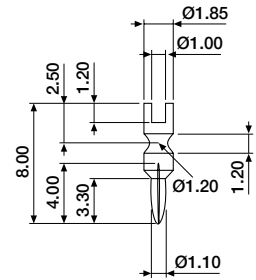

KPT-1022-0000 tin plated

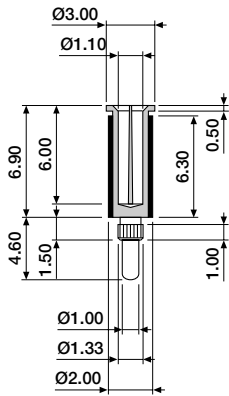

KPT-1168-0020 gold plated

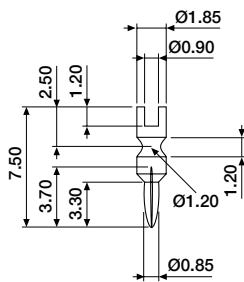

KPT-1233-0000 tin plated
KPT-1233-0020 gold plated

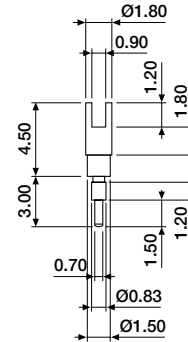

KPT-1234-0000 tin plated
KPT-1234-0020 gold plated

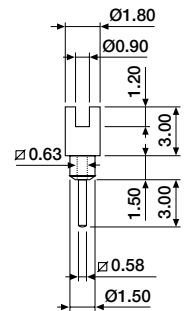

KPT-1236-0020 gold plated

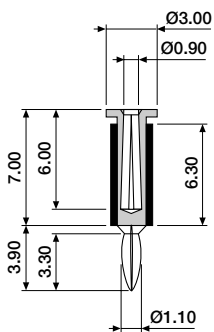

KPT-1555-0020 gold plated

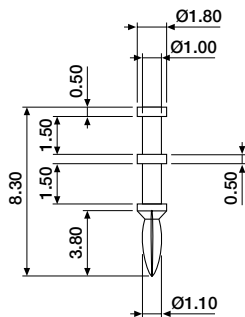

KPT-1607-0000 tin plated
KPT-1607-0020 gold plated

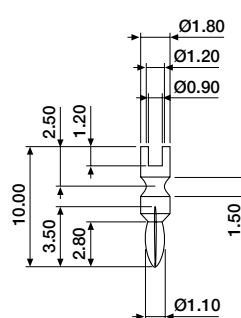

KPT-1624-0000 tin plated
KPT-1624-0020 gold plated

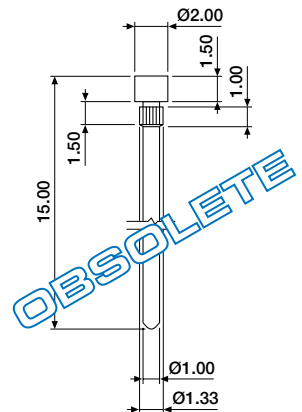

KPT-2840-0000 tin plated
KPT-2840-0020 gold plated